

MODEL: 27TMX with POD vent
DIMENSIONS: inches (mm)
BATTERY: Flooded/wet lead-acid battery
COLOR: Maroon (case/cover)
MATERIAL: Polypropylene



PRODUCT SPECIFICATIONS

BCI GROUP SIZE	TYPE	CAPACITY ^A Minutes		CAPACITY ^B Amp-Hours (AH)			ENERGY (kWh)	TERMINAL Type ^E	DIMENSIONS ^C Inches (mm)			WEIGHT lbs. (kg)
		@25 Amps	@75 Amps	5-Hr Rate	20-Hr Rate	100-Hr Rate			100-Hr Rate	Length	Width	
12 VOLT DEEP CYCLE BATTERY - with T2 TECHNOLOGY™												
27	27TMX	175	45	85	105	117	1.40	5, 9	12-3/4 (324)	6-3/4 (171)	9-3/4 (248)	55 (25)

- A. The number of minutes a battery can deliver when discharged at a constant rate at 80°F (27°C) and maintain a voltage above 1.75 V/cell. Capacities are based on peak performance.
 - B. The amount of amp-hours (AH) a battery can deliver when discharged at a constant rate at 77°F (25°C) for Signature Line and maintain a voltage above 1.75 V/cell. Capacities are based on peak performance.
 - C. Dimensions are based on nominal size. Dimensions may vary depending on type of handle or terminal. Batteries to be mounted with .5 inches (12.7 mm) spacing minimum.
 - D. Dimensions taken from bottom of the battery to the highest point on the battery. Heights may vary depending on type of terminal. Trojan's battery testing procedures adhere to both BCI and IEC test standards.
 - E. Terminal images are representative only.
- Trojan's Battery testing procedures adhere to both BCI and IEC test standards.

CHARGING INSTRUCTIONS

CHARGER VOLTAGE SETTINGS (AT 77°F/25°C)					
System Voltage	6V	12V	24V	36V	48V
Absorption Charge	7.40	14.8	29.6	44.4	59.2
Float Charge	6.60	13.2	26.4	39.6	52.8
Equalize Charge	7.75	15.5	31.0	46.5	62.0

Do not install or charge batteries in a sealed or non-ventilated compartment. Constant under or overcharging will damage the battery and shorten its life as with any battery.





CHARGING TEMPERATURE COMPENSATION

.028 VPC for every 10°F (5.55°C) above or below 77°F (25°C) (add .028 VPC for every 10°F (5.55°C) below 77°F and subtract .028 VPC for every 10°C above 77°F).

OPERATIONAL DATA

Operating Temperature	Self Discharge
-4°F to 113°F (-20°C to +45°C). At temperatures below 32°F (0°C) maintain a state of charge greater than 60%.	5 – 15% per month depending on storage temperature conditions.

TERMINAL CONFIGURATIONS

5 LT	L-Terminal	 <p><i>Terminal Height Inches (mm)</i> 1-3/4 (43) <i>Torque Values in-lb (Nm)</i> 100 – 120 (11 – 14) <i>Through-hole Diameter (mm)</i> 3/8 (10)</p>
7 UT	Universal Terminal	 <p><i>Terminal Height Inches (mm)</i> 1-1/8 (28) <i>Torque Values in-lb (Nm)</i> 95 – 105 (11 – 12) <i>Through-hole Diameter (mm)</i> 5/16 – 18 (8)</p>
8 AP	Automotive Post Terminal	 <p><i>Terminal Height Inches (mm)</i> 15/16 (24) <i>Torque Values In-lb (Nm)</i> 50 – 70 (6 – 8)</p>
9 WNT	Wingnut Terminal	 <p><i>Terminal Height Inches (mm)</i> 15/16 (24) <i>Torque Values in-lb (Nm)</i> 95 – 105 (11 – 12) <i>Bolt Size</i> 5/16 – 18</p>

BATTERY DIMENSIONS (shown with WNT)

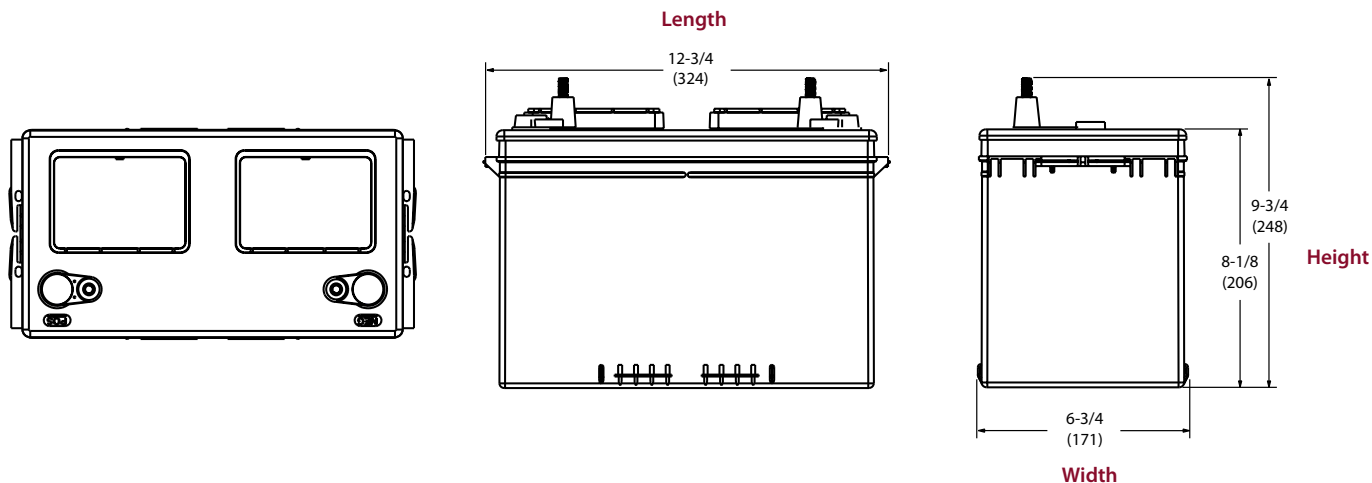

TROJAN 27TMX PERFORMANCE

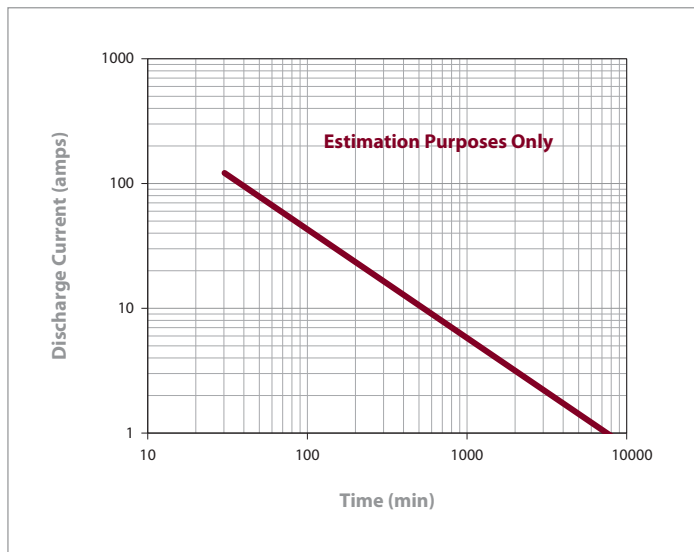

PERCENT CAPACITY VS. TEMPERATURE

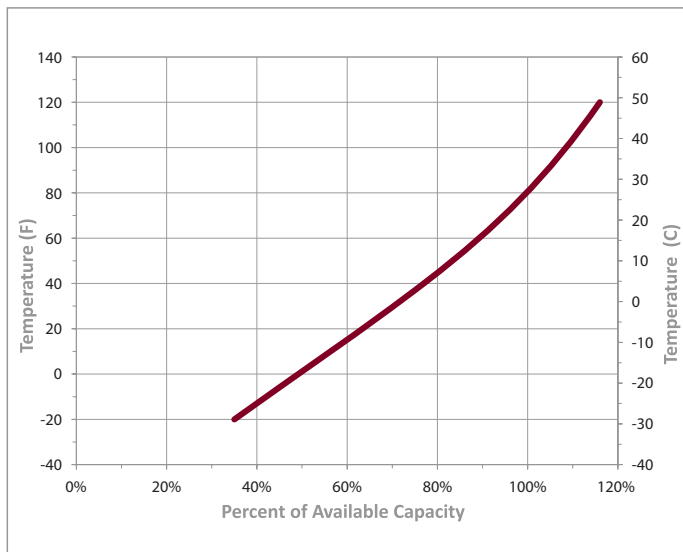

Trojan batteries are available worldwide through Trojan's Master Distributor Network. We offer outstanding technical support, provided by full-time application engineers.

For a Trojan Master Distributor near you, call 800.423.6569 or + 1.562.236.3000 or visit www.trojanbattery.com

12380 Clark Street, Santa Fe Springs, CA 90670 • USA